

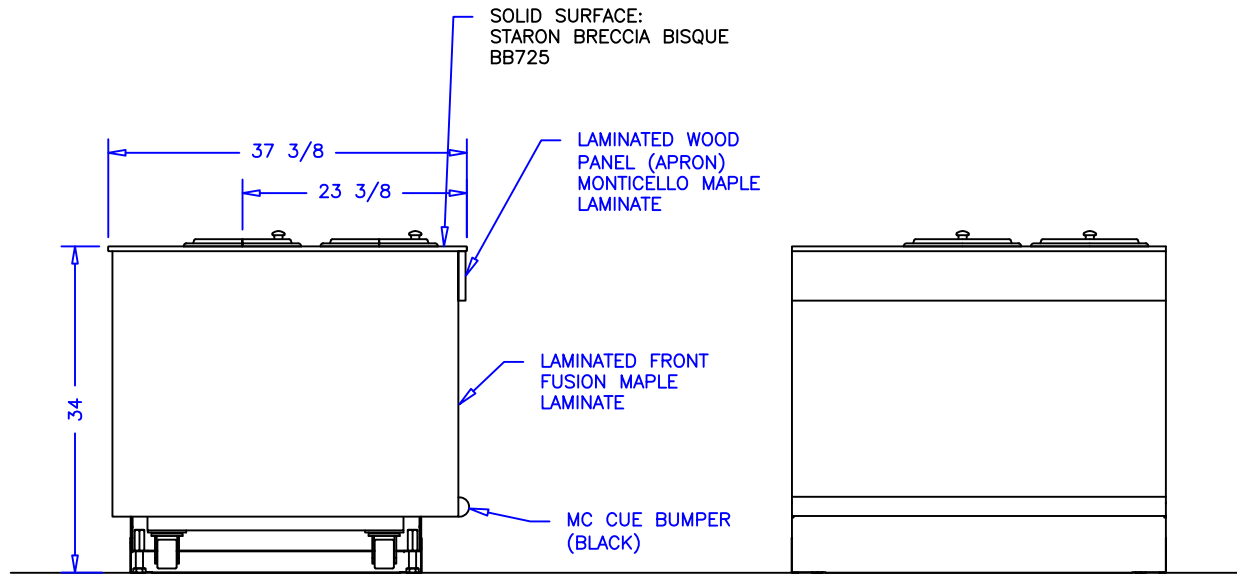

CASE SPECIFICATIONS:

ELECTRICAL 115VAC, 60HZ, 1PH.
 SOUP WELLS: 27.6A
 TOTAL: 27.6A
 MCA: 35.0A

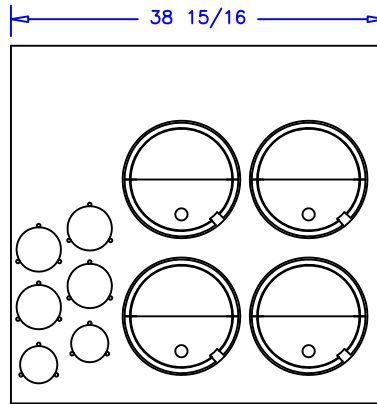

NOTES:

1. OPTIONS NOT SHOWN ON DRAWING SHOULD BE LISTED IN WRITTEN PROPOSAL AND LISTED ON PURCHASE ORDER.
2. ELEC. CONNECTION: 115V/230V, 4x4 SUPPLY BOX AS NEEDED.
3. EXPANSION VALVES: SPORLAN "Q" SERIES STANDARD UNLESS OTHERWISE SPECIFIED.
4. DEFROST CONTROL: REMOTE CASES (N/A, DIGITAL CASE CONTROLLERS AVAILABLE), OPTIONAL CONDENSING UNIT (DIGITAL CASE CONTROLLER).
5. THERMOSTATS & LIQUID LINE SOLENOID VALVES: OPTIONAL.
6. DRAIN: 1 1/2 INCH PVC.
7. SPECIFICATIONS SUBJECT TO CHANGE WITHOUT NOTICE.

AUTHORIZATION (PRINT):		DATE:		 börgeren systems		DRAWN BY: D HUNT	
SIGNATURE:						CHECKED BY:	
				SCALE: 1:24		DATE: 5-4-09	
				3FT SOUP BAR			
DATE		REV.		DIM: INCH		DRAWING NUMBER	
REVISION		TOL:				P5630	